

ROOF FANS

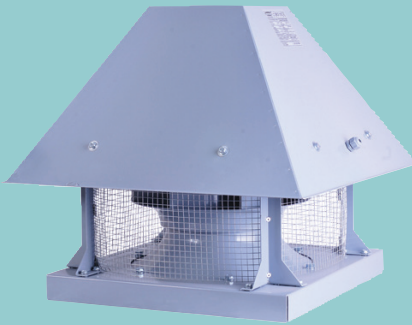

BRCF

AC DIRECT DRIVE ROOF FANS Horizontal Outlet

BRCF is used as a smoke exhaust fan in industrial and residential areas to vent out the hot gases through chimney. Max. transferred air temperature is 120°C.

Technical Drawings

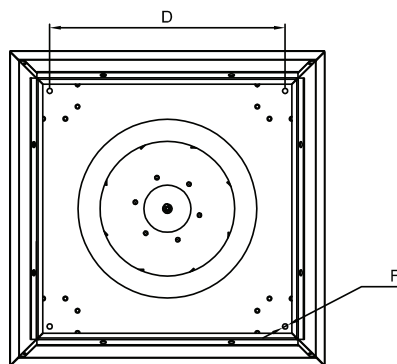
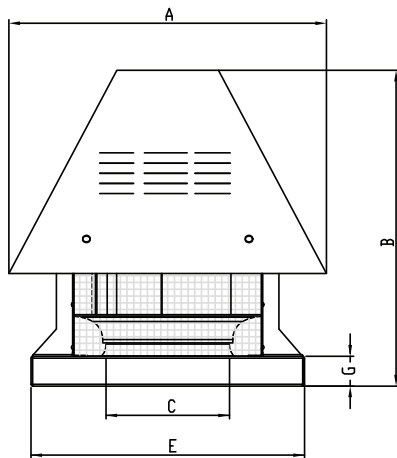

- MATERIAL** : The housing is made of electrostatic powder coated sheet steel, fan is made of sheet steel with backward curved impeller and welded execution.
- INSULATION CLASS** : Class F
- MAX. AIR TEMPERATURE** : 120°C
- DIRECTIVE** : EN 60335-1, EN 60335-2-80
- SPEED CONTROL** : Speed can be adjusted using an optional controller
- APPLICATION AREAS** : Fan series is perfect to use in residential, commercial and industrial environments, especially where hot air and smoke is needed to be transferred. For example cafes, restaurants, gymnasiums, shopping centers, hospitals, factories, offices etc.

Accessories



BSC-F

TYPE	A	B	C	D	E	F	G
BRCF 280	524	505	165	354	404	10	44
BRCF 315	593	546	185	404	454	10	44
BRCF 355	655	546	234	450	500	10	44
BRCF 400	655	574	270	450	500	12	44
BRCF 450	730	568	282	530	580	12	44
BRCF 500	800	665	320	590	640	12	44
BRCF 560	856	723	360	650	700	12	44
BRCF 630	986	888	448	660	730	12	54
BRCF 710	1080	958	450	710	780	12	54
BRCF 800	1190	1130	542	850	900	12	54

Dimensions are in (mm)

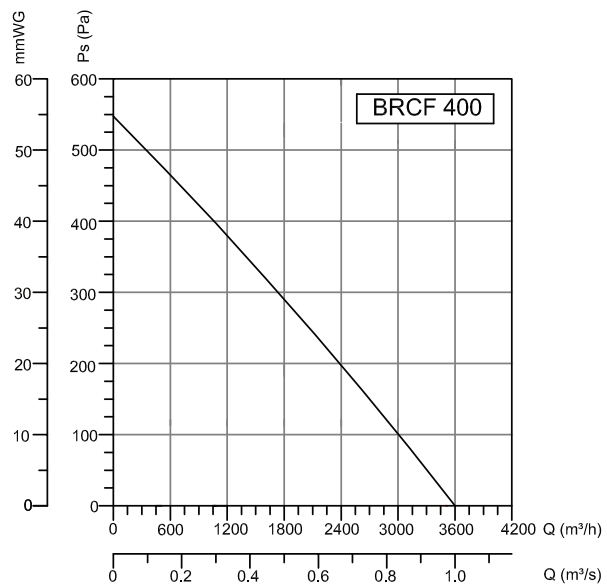
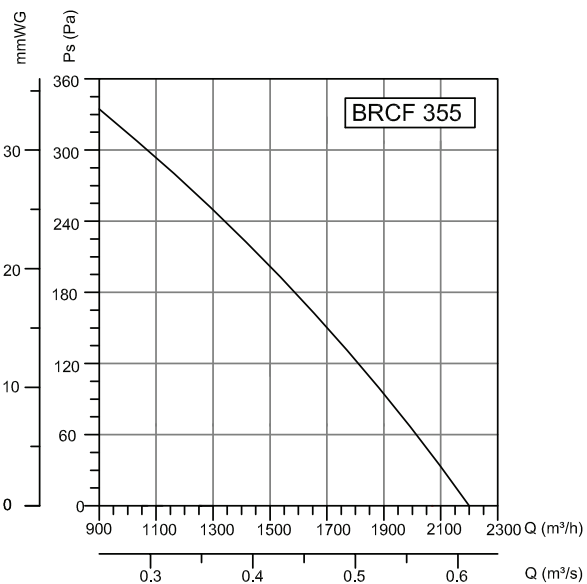
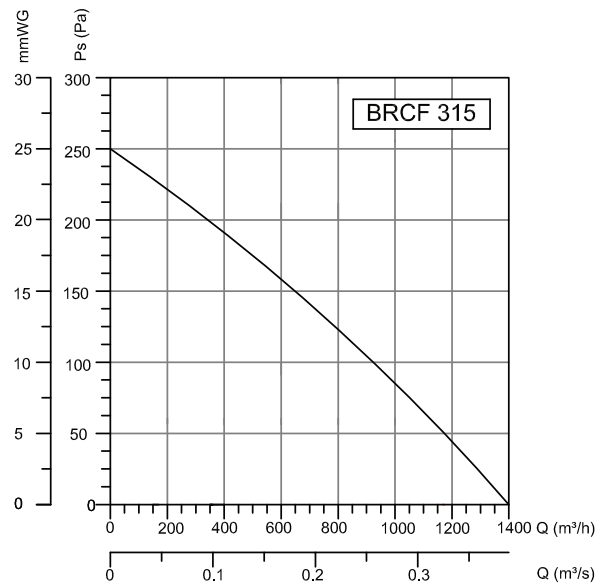
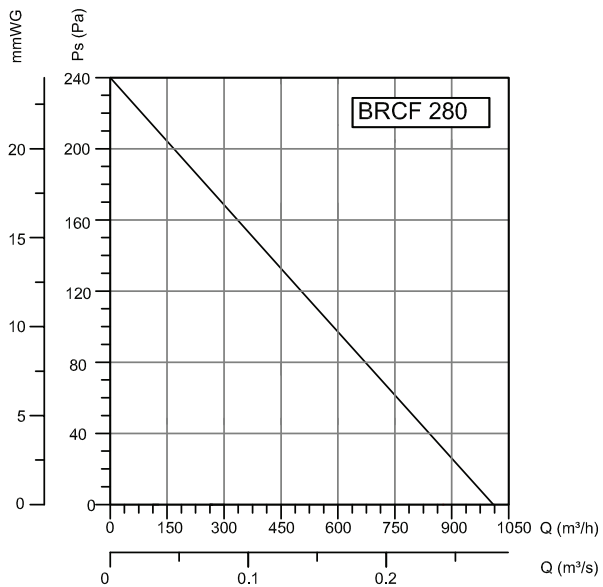

TYPE	VOLTAGE	FREQUENCY	POWER	CURRENT	SPEED	AIR FLOW	SOUND PRESSURE LEVEL	WEIGHT
	V	Hz	KW	(A)	d/d	m³/h	dB(A)	kg
BRCF 280M / BRCF 280T	230/380	50	0,37	2,6/1,15	1400	1000	42	35
BRCF 315M / BRCF 315T	230/380	50	0,37	2,6/1,15	1400	1415	44	42
BRCF 355M / BRCF 355T	230/380	50	0,37	2,6/1,15	1400	2200	45	50
BRCF 400M / BRCF 400T	230/380	50	0,55	3,3/1,5	1400	3600	48	55
BRCF 450M / BRCF 450T	230/380	50	0,75	4,6/2	1400	4400	55	62
BRCF 500M / BRCF 500T	230/380	50	1,1	7,1/2,6	1400	8500	60	68
BRCF 560M / BRCF 560T	230/380	50	1,5	9,3/3,5	1400	10000	65	75
BRCF 630T	380	50	3	6,45	1000	11200	80	127
BRCF 710T	380	50	4	8,2	1000	12800	83	150
BRCF 800T	380	50	7,5	15,3	1000	16000	85	216

DUCT FANS

ROOF FANS

AXIAL FANS

RADIAL FANS

PLASTIC FANS

VENTILATORS

SMOKE EXHAUST SYSTEMS

ACCESSORIES

ROOF FANS

